



GÉANT2

"The Biosphere of Grids and Networks"

NORDUnet2008

GÉANT3 - European R&E Networking after 2008

Vasilis Maglaris

maglaris@netmode.ntua.gr

Chairman, European NREN Policy Committee - GÉANT Consortium
Professor, National Technical University of Athens – NTUA

NORDUnet Conference

Helsinki, Finland - April 11, 2008



GÉANT2

NTUA – NATIONAL TECHNICAL
UNIVERSITY OF ATHENS



R&E Networking Model in Europe

- **A 3-tier Federal Architecture**, partially subsidized by National and EU Research & Education funds:
 - The Campus Network (LAN/MAN) > 3,500 Institutions, >30 M Users
 - The 34 NREN's (MAN/WAN)
 - The Pan-European Interconnection: **TEN34 à TEN155 à GÉANT** (GN1 in FP5) **à GÉANT2** (GN2 in FP6): **Hybrid Optical Backbone (+ Cross Border Fibers) à GÉANT3** (GN3 ? in FP7)
- **Total GN2 Cost: 40 M€/year (co-funded by the EC and NREN's)**

GN2 EC Subsidy < 10% of total European R&E Networking Cost

- **GÉANT Governance:** NREN Policy Committee
- **Project Management:** Exec, DANTE

European NREN's – GÉANTn: A Growing Success Story - Why?



- Century old Telecom (+ 40 years ARPAnet - Internet) experience: Proven strong *“Network Externalities”* à Sharing tradition
- Industry needs for *Next Generation Network* proofs of concept, synergy with R&E community: The ARPAnet paradigm @ the US of America, inspiring the *“US of Europe”*
- **Foresight** of National + EU funding authorities, triggered by NREN planning – SERENATE, EARNEST Studies
- A decade (+) of success in serving R&E needs of the Continent à Smoothing-out *“digital divides”* & enabling powerful education communities (educators, students, pupils?)
- NREN's as utilities for the R&E communities – extending the *“commons”* principle aka. Open Source S/W, Wikipedia...
- **Solidarity** – human networking within the NREN community
- Stable **Governance**: NREN Policy Committee (NREN PC)



The NREN Policy Committee

- | | |
|---|--|
| <ol style="list-style-type: none">1. Austria (ACOnet)2. Belgium (BELNET)3. Bulgaria (ISTF)4. Croatia (CARNet)5. Czech Republic (CESNET)6. Cyprus (CYNET)7. Germany (DFN)8. Estonia (EENet)9. France (RENATER)10. Greece (GRNET)11. Hungary (HUNGARNET)12. Ireland (HEANet)13. Israel (IUCC)14. Italy (GARR)15. Latvia (LATNET)16. Lithuania (LITNET)17. Luxembourg (RESTENA)18. Malta (UoM)19. Netherlands (SURFNET) | <ol style="list-style-type: none">20. Nordic Countries – Denmark, Finland, Iceland, Norway, Sweden (NORDUNET)21. Poland (PSNC)22. Portugal (FCCN)23. Romania (RoEduNet)24. Russia (JSCC)25. Slovakia (SANET)26. Slovenia (ARNES)27. Spain (RedIRIS)28. Switzerland (SWITCH)29. Turkey (ULAKBIM)30. United Kingdom (UKERNA) <p><u>PLUS NON-VOTING MEMBERS:</u>
Delivery of Advanced Network Technologies to Europe Ltd. (DANTE)
Trans-European Research & Education Networking Association (TERENA)</p> <p>PERMANENT OBSERVERS: CERN, AMRES, MARNET</p> |
|---|--|

NREN's & GÉANTn: e-Science Enablers + Networking R&D Platforms

- NREN's – GÉANT2/3 provide cost effective **e2e switched & light path connectivity** within the Dark Fiber Cloud (DWDM footprint)
 - + Global **IPv4 – IPv6 coverage** and **Hybrid** networking services
 - + Multi-domain Network management, resiliency & support
- *e-Science* (GRID) Virtual Organizations obtain, production quality hybrid networking, beyond leasing individual circuits, wave-lengths or dark fibers
- *e-Infrastructures* as equalizers, reduce the **DIGITAL DIVIDES** in Europe & globally: **Big Science affordable via virtual e-Science**
- NRENs – GÉANT stimulate **Network Research** & enable novel concept evaluation - **emulations** in a global production environment via virtualization of facilities & services

Bandwidth Requirements per User

SERENATE Study Final Report, 2003

Cees De Laat, David Williams et. al.

"The Biosphere of Grids and Networks"

NORDUnet2008

of users

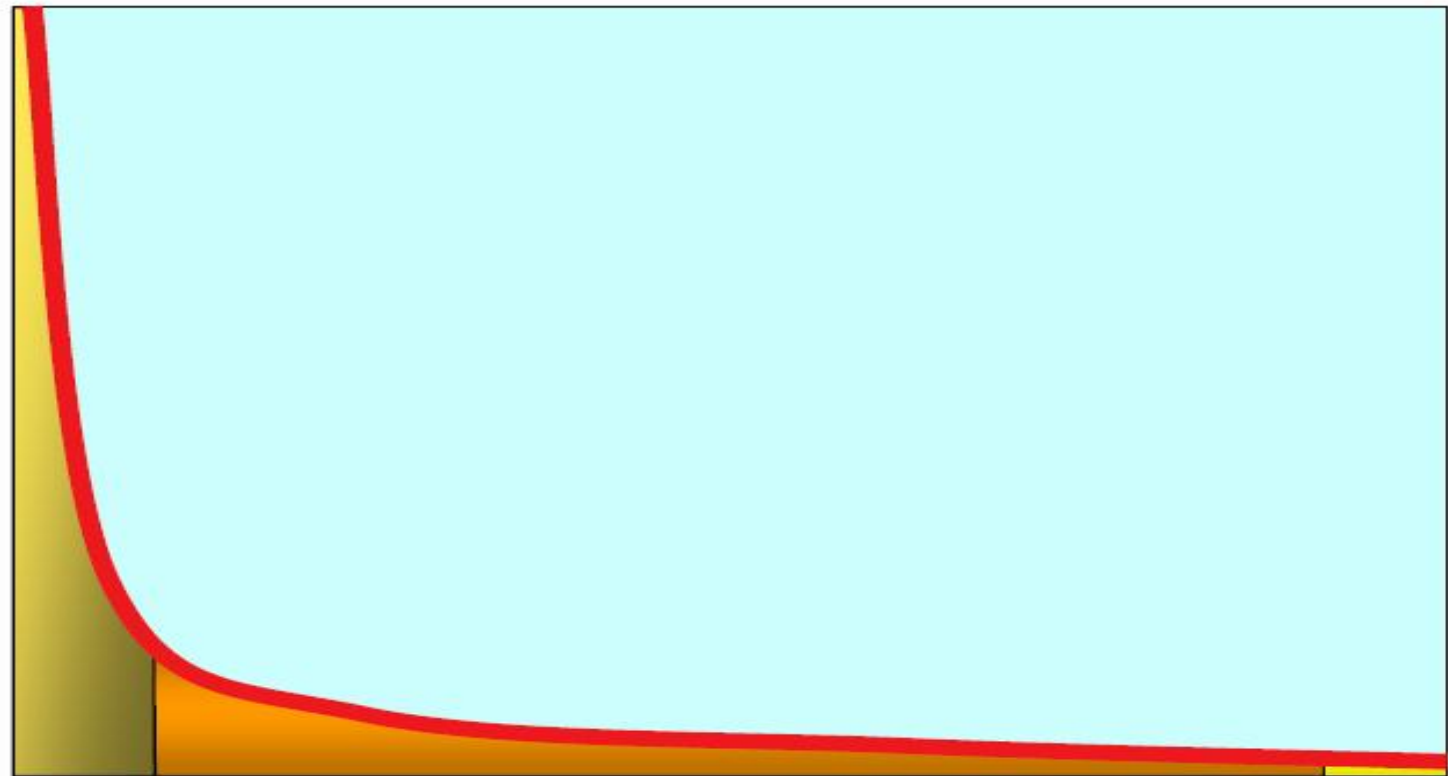

ADSL

GigE

The GÉANT2 Network

"The Biosphere of Grids and Networks"

NORDUnet2008

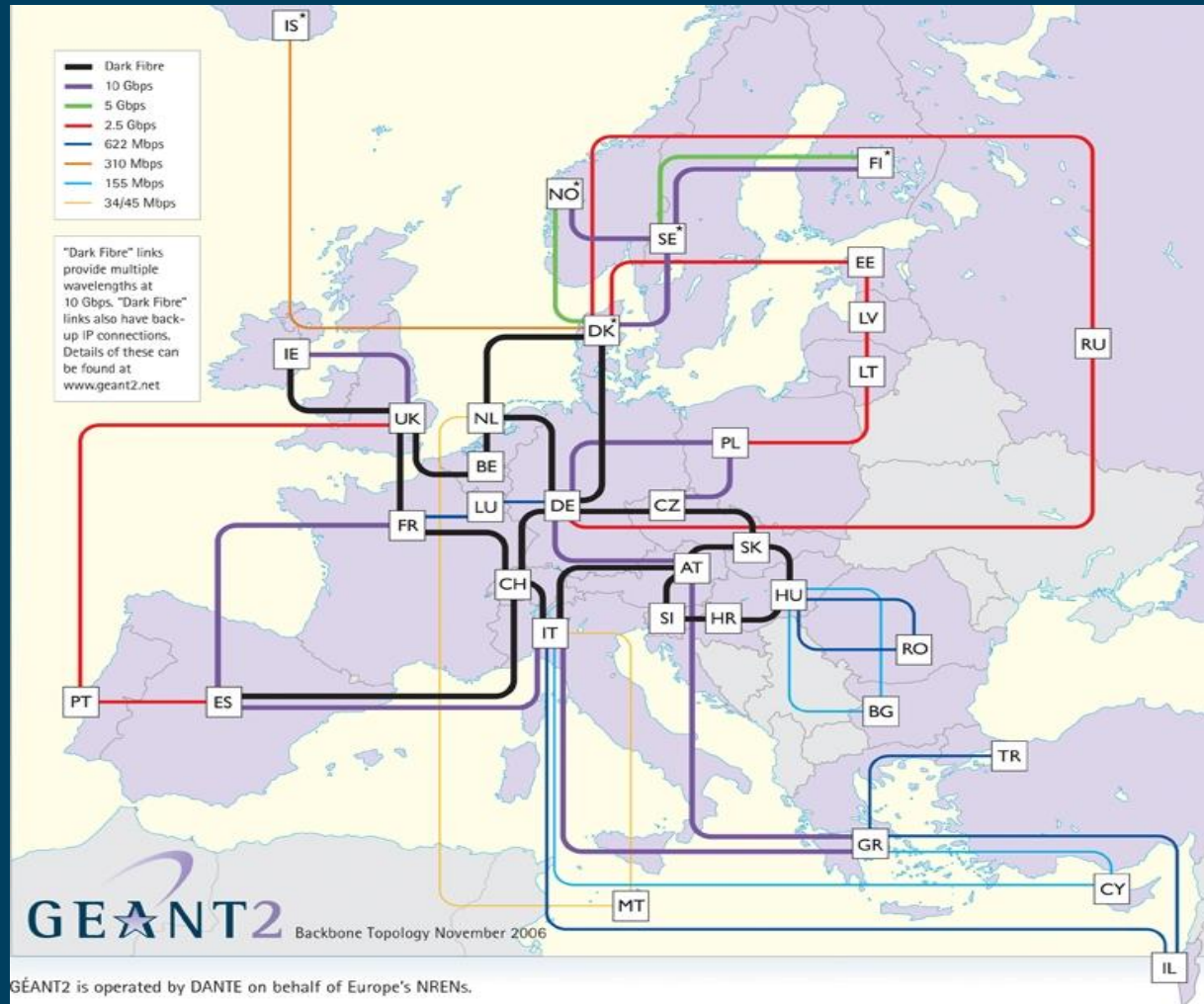

GÉANT2 Topology

15+ NRENs interconnected within the Dark Fibre (DF) "cloud"

Rest, via leased "lambda" and SDH circuits

European R&E 10 Gig+ Footprint, March 2008
(based on data by **DANTE** & **NRENs**)

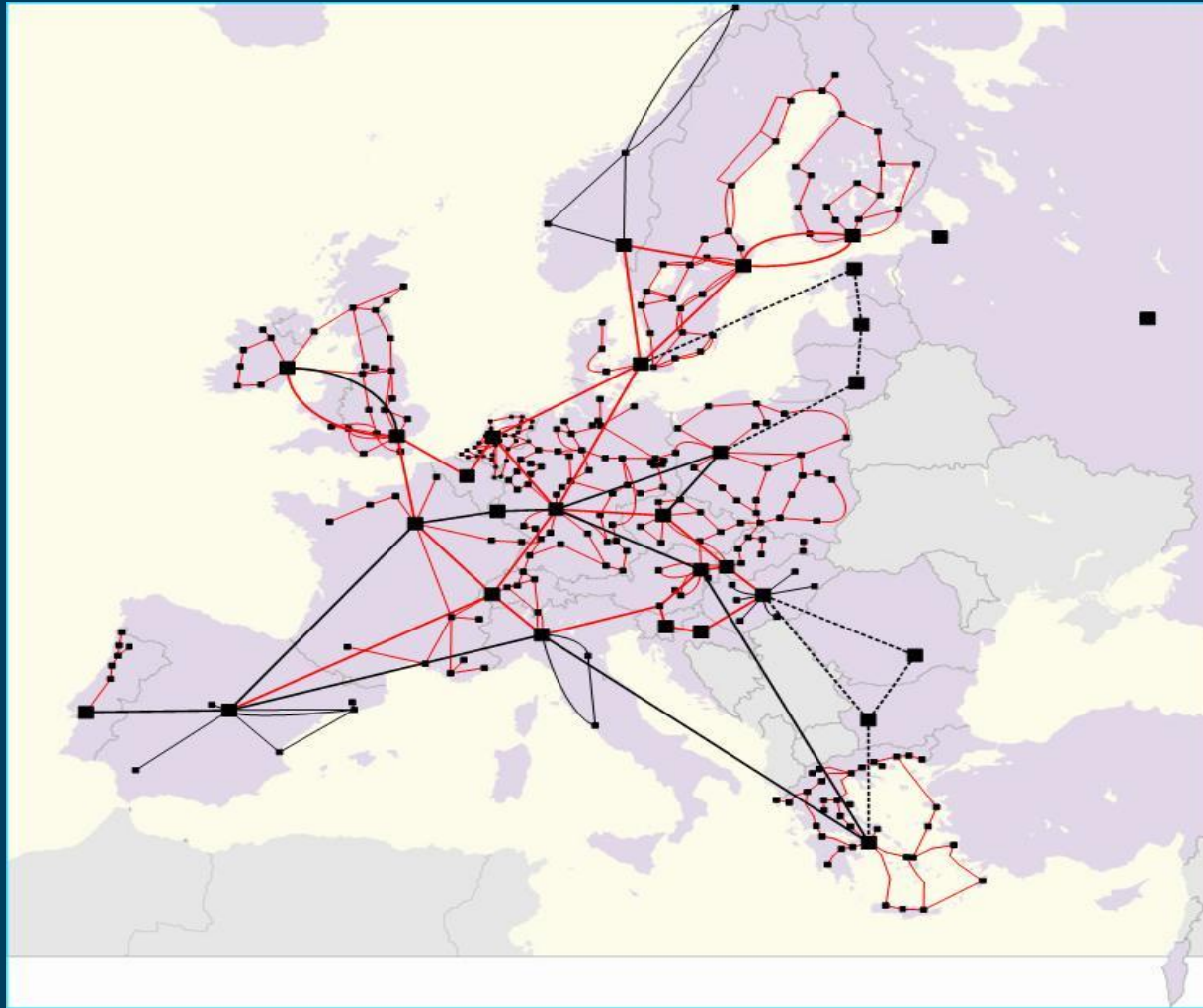

Enables
end-to-end
Hybrid Networking &
Optical Private
Networking (**OPNs**) for
e-Science Projects

LHC TIER0 – TIER1 Optical Private Network - OPN, (Scenario based on work by **Roberto Sabatino** DANTE CTO)

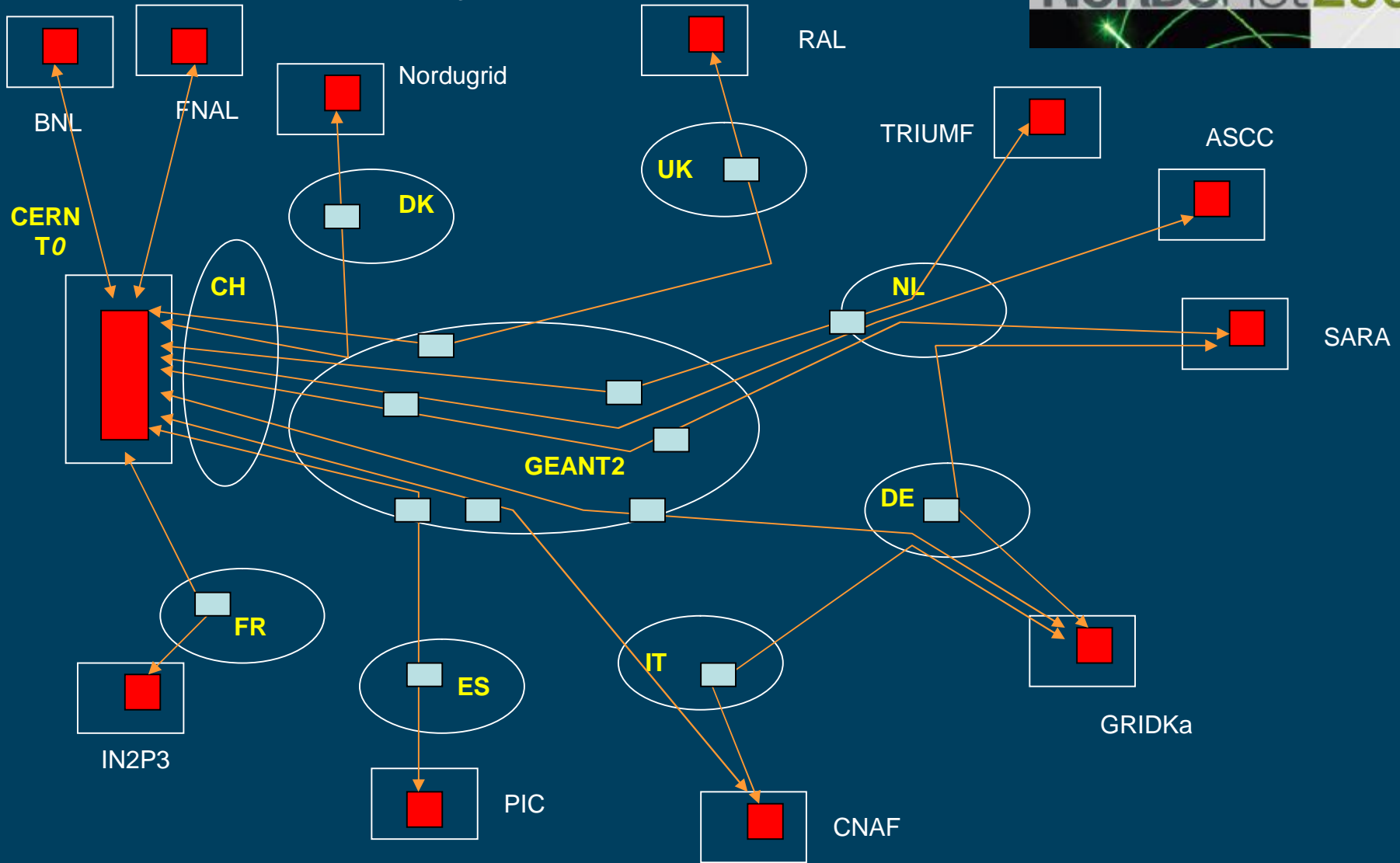

NTUA – NATIONAL TECHNICAL
UNIVERSITY OF ATHENS



Wavelengths on GÉANT2 - February 2008

(based on presentation by *Hans Döbbling* DANTE G.M.)

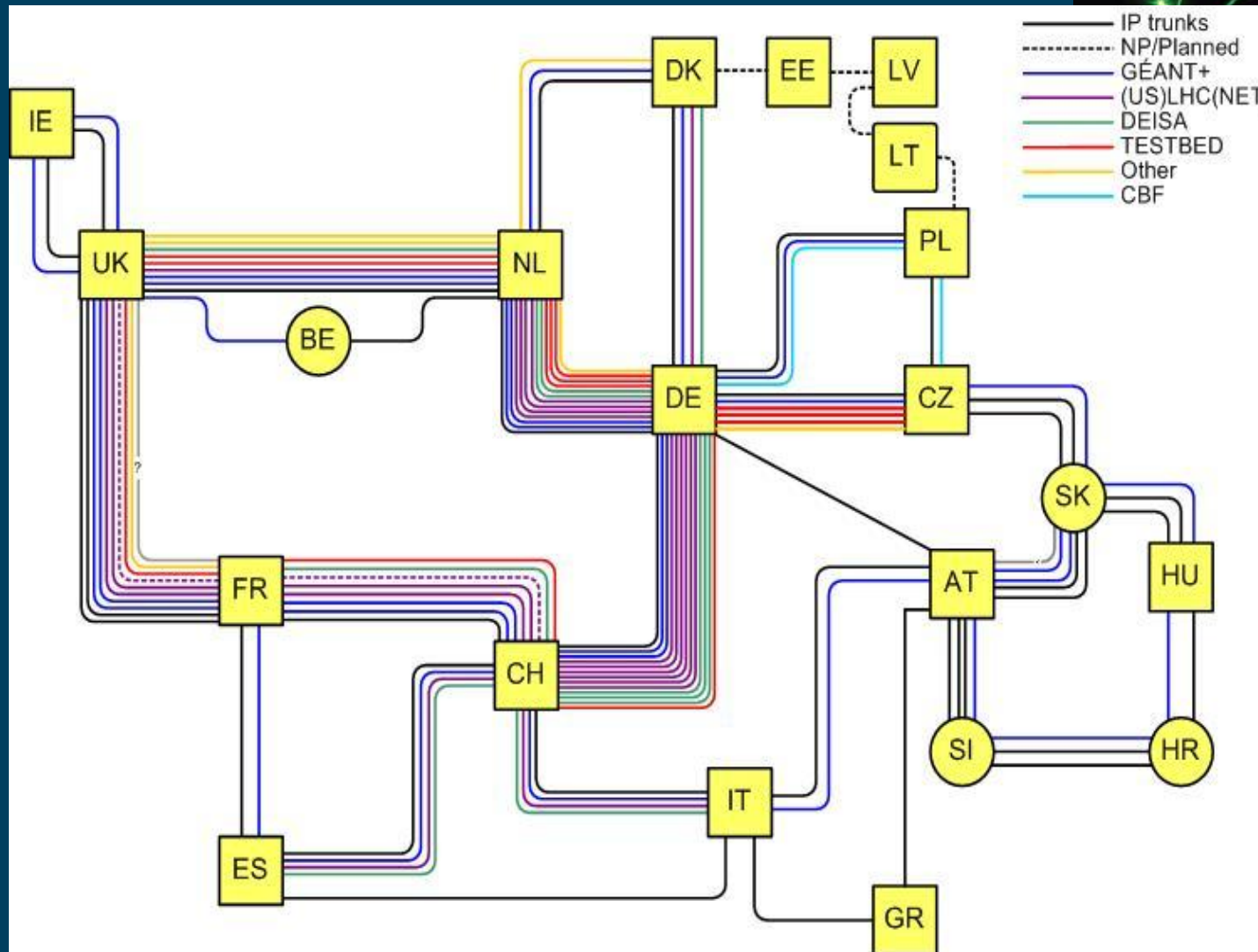

Is there Life after GÉANT2 ?

- Advances in networking technologies: **Terabit** optical networking (enabling the *GTRN – Global Terabit Research Networking* vision), collapsed backbone topology trends (*carrier Ethernet...*), **virtualization** (*logical routers, service oriented middleware, cloud computing...*)
- **Time is ripe for Europe to profit from its long-term investment on R&E Networking**
- GÉANT is a yardstick for global initiatives
 - Internet²: Accelerated hybrid networking development (HOPI à DCN, Dynamic Circuit Network)
 - DICE Group (GÉANT2/3 via *DANTE, Internet2, Canary, ESnet*)
- Growing **global role & commitments** of the GÉANT community

GEANT2 At the Heart of Global Research Networking

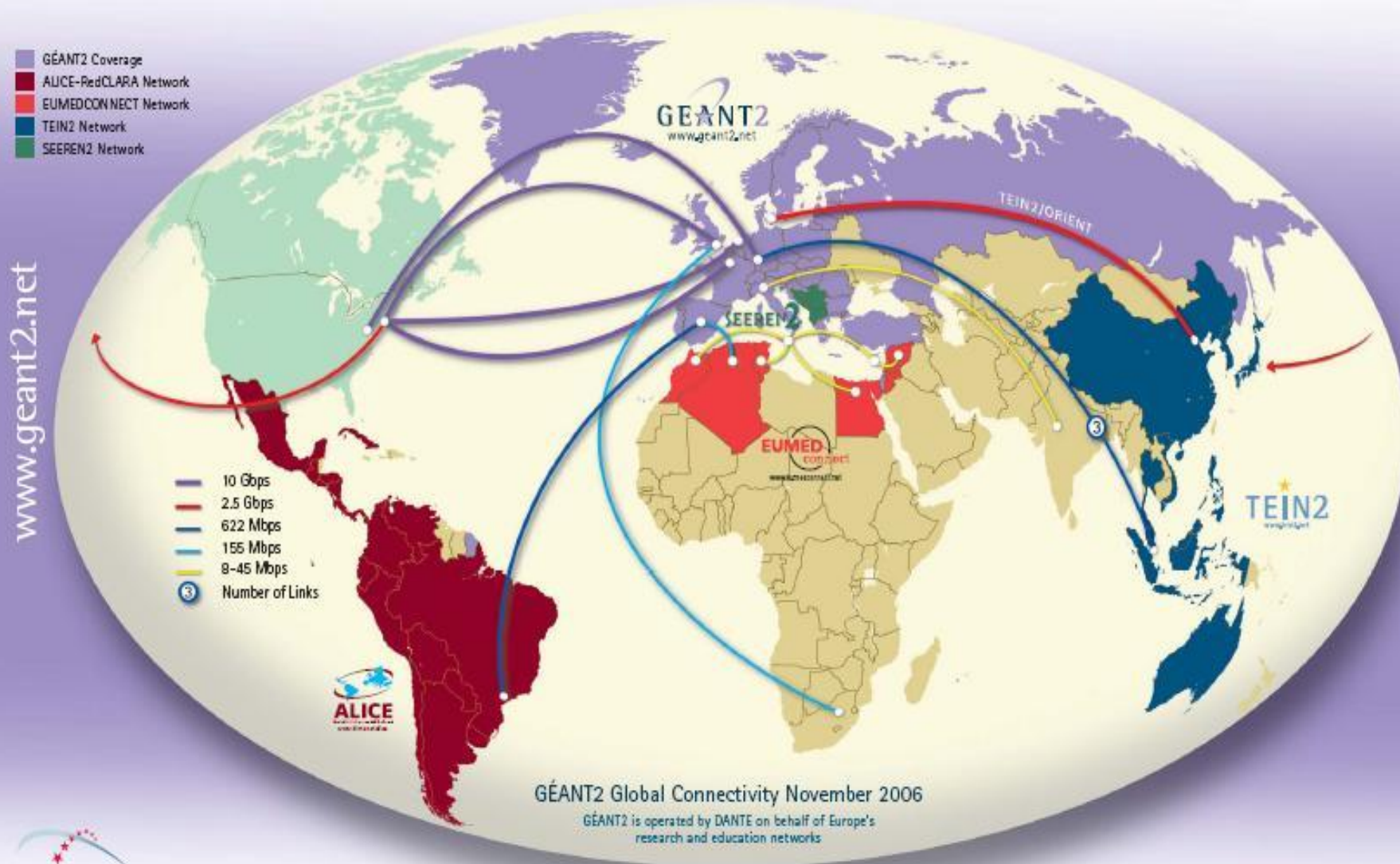

GÉANT3: A factory of (virtualized) networking resources & services (1/3)

- Extending the service portfolio to production quality multi-domain hybrid networking
 - Campus, NRENs, GÉANT3...
 - Innovate to resolve the multi-domain impasse:

Note that there are up to now only TWO inter-domain control plane (signaling) success stories: SS7 (telephony) & BGP (Internet)

- Integrating Control Plane Functionality within Distributed Computing (GRID, SOA) Middleware
- Translating into a common view an enriched set of per-domain information, feedback to standardization bodies (IETF, OIF, OGF)

GÉANT3: A factory of (virtualized) networking resources & services (2/3)

- Multi-domain services focus on management services to NRENs enabling:
 - Distributed ticketing workflows, performance monitoring (*PERT+*)
 - Security (incident reporting, anomaly detection)
 - Confederated Roaming (*Eduroam*), PKI & ID management (*eduGAIN*)
 - Multi-protocol monitoring at 10-100 Gig speeds (*perfSONAR+*)
 - End-to-end Provisioning (*E2ECU*)
 - Automated multi-domain provisioning (*AutoBAHN*)

Automatic Bandwidth Provisioning: The AutoBAHN Concept

(based on a presentation by *Afrodite Sevasti*, GRNET)

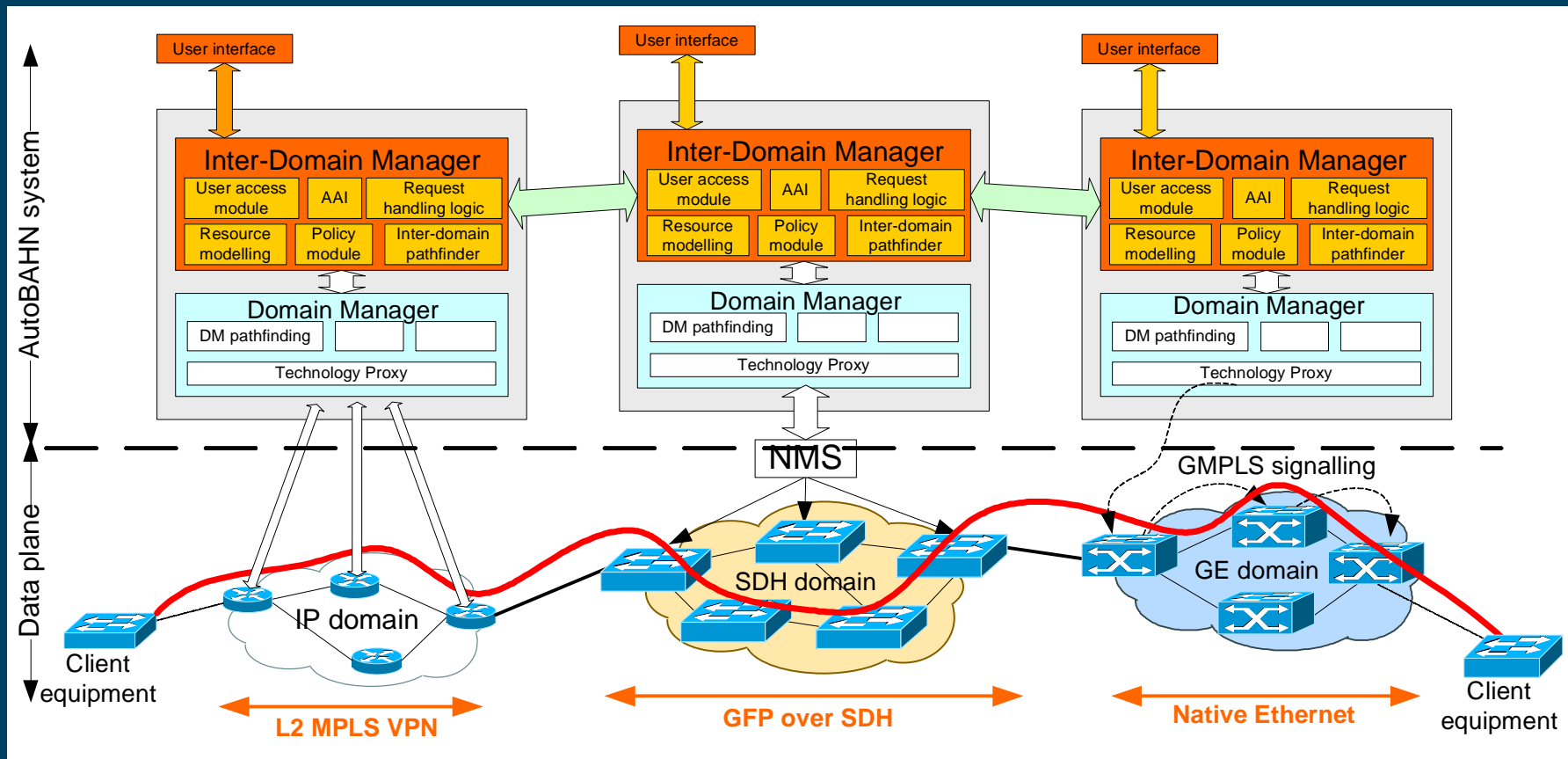

GÉANT3: A factory of virtualized networking resources & services (3/3)

- Extend the NREN – GÉANT Services to provision of integrated IT services that include:
 - Multi-domain hybrid networking services
 - Storage (?)
 - Computing (?)
- Converging e-Infrastructures
 - Relationship with Grid – Supercomputing
 - Towards **cloud** computing aka. Google, Amazon, IBM...?
 - Now more than ever the **NETWORK IS THE COMPUTER**

Summarizing the GÉANT3 Vision

- To create an innovative **multi-domain hybrid networking** environment, using advanced transmission & switching technologies
- To enable R&E users through their Organizations with **flexible and scalable production quality services** via their constituent NRENs
- To be an enabler for Global R&E networking supporting international e-Science initiatives, creating a **Global Virtual Village** to house researchers & educators around the world
- To contribute to standards as a key participant in European & Global efforts towards the **Network of the Future**

Preparations for a GN3 Proposal

- **Two task forces** established by the NREN PC (**September 2007**):
 - **GN3 Membership Committee:** Artur Binczewski (*PSNC*), Thomas Brunner (*SWITCH*), Dai Davies (*DANTE*), Jan Gruntorad (*CESNET, Chair*), SabineJaume-Rajaonia (*RENATER*), Karel Vietsch (*TERENA*)
 - Rules of membership, categories (**December 2007**)
 - **GN3 High Level Technical Strategy:** Erik-Jan Bos (*SURFNet*), Mauro Campanella (*GARR*), Hans Döbbling (*DANTE*), Lars Fischer (*NORDUNet*), David Foster (*CERN*), Vasilis Maglaris (*NREN PC, Chair*), Dorte Olesen (*TERENA*), Roberto Sabatino (*DANTE*), Afrodite Sevasti (*GRNET*)
 - Preliminary report (**October 2007**)
 - Green paper (consultation phase amongst NRENs, completed by the **end of March 2008**)
 - White paper (**end of April 2008**)
- **GN3 Proposal Review Board:** Established by the NREN PC (**Geneva, April 4 2008**) to integrate work of 2 committees in accordance with NREN viewpoints
- Governance, management issues & DANTE restructuring

GÉANT3 & its Global Peers: Help shaping the Internet of the future



- GÉANT3 will be a key player in European & Global initiatives on the **Network of the Future**
 - US Initiatives
 - GENI <http://www.geni.net/> (clean slate)
 - VINI <http://www.vini-veritas.net/> (on Internet2, NLR)
 - Japanese Initiatives
 - AKARI <http://akari-project.nict.go.jp/eng/index2.htm>
 - European Initiatives
 - FEDERICA <http://www.fp7-federica.eu/> (on GÉANT2, NRENs)
 - FIRE ICT Projects <http://cordis.europa.eu/fp7/ict/fire/>



FEDERICA @ a Glance

- Federated **E**-infrastructures **D**edicated to **E**uropean **R**esearchers
Innovating in **C**omputing network **A**rchitectures
- RI FP7 Project, based on *stakeholders on network research*:
 - NRENs, GEANT2, end-users and vendors
 - Coordinator: GARR (the Italian NREN)
- Aims to:
 - Employ initially up to 1 Gbps MPLS & GigE circuits from NRENs and GEANT2 (GEANT+ service)
 - Install open source routers, programmable routers and open API switches in selected NREN PoPs
 - Develop a *tool-bench* for managing virtual e2e facilities
 - Provide virtualized facilities to end-users: Research groups on the network of the future, requiring *disruptive emulations*
 - Pave the way for eventual GN3 involvement

The FEDERICA Concept

"The Biosphere of Grids and Networks"

NORDUnet2008

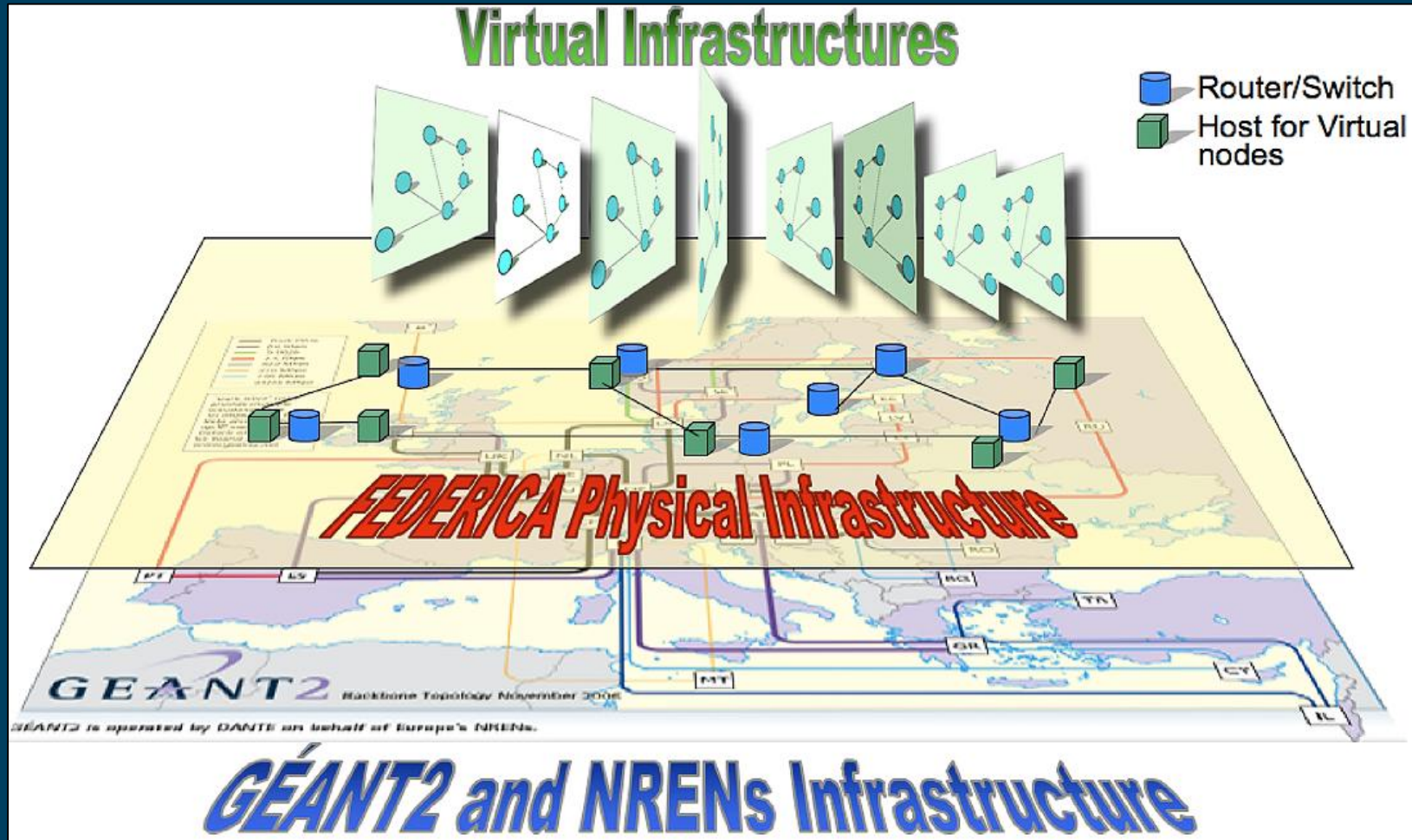

FEDERICA Partners

- GARR (coordinator)
- CESNET
- DFN
- FCCN
- GRNET
- HUNGARNET
- PSNC
- RedIRIS
- SWITCH
- TERENA
- i2CAT
- KTH
- ICCS
- UPC
- Juniper
- Martel Consulting
- HEANet
- DANTE
- Politecnico di Torino
- NORDUNET

The FEDERICA Network Slice

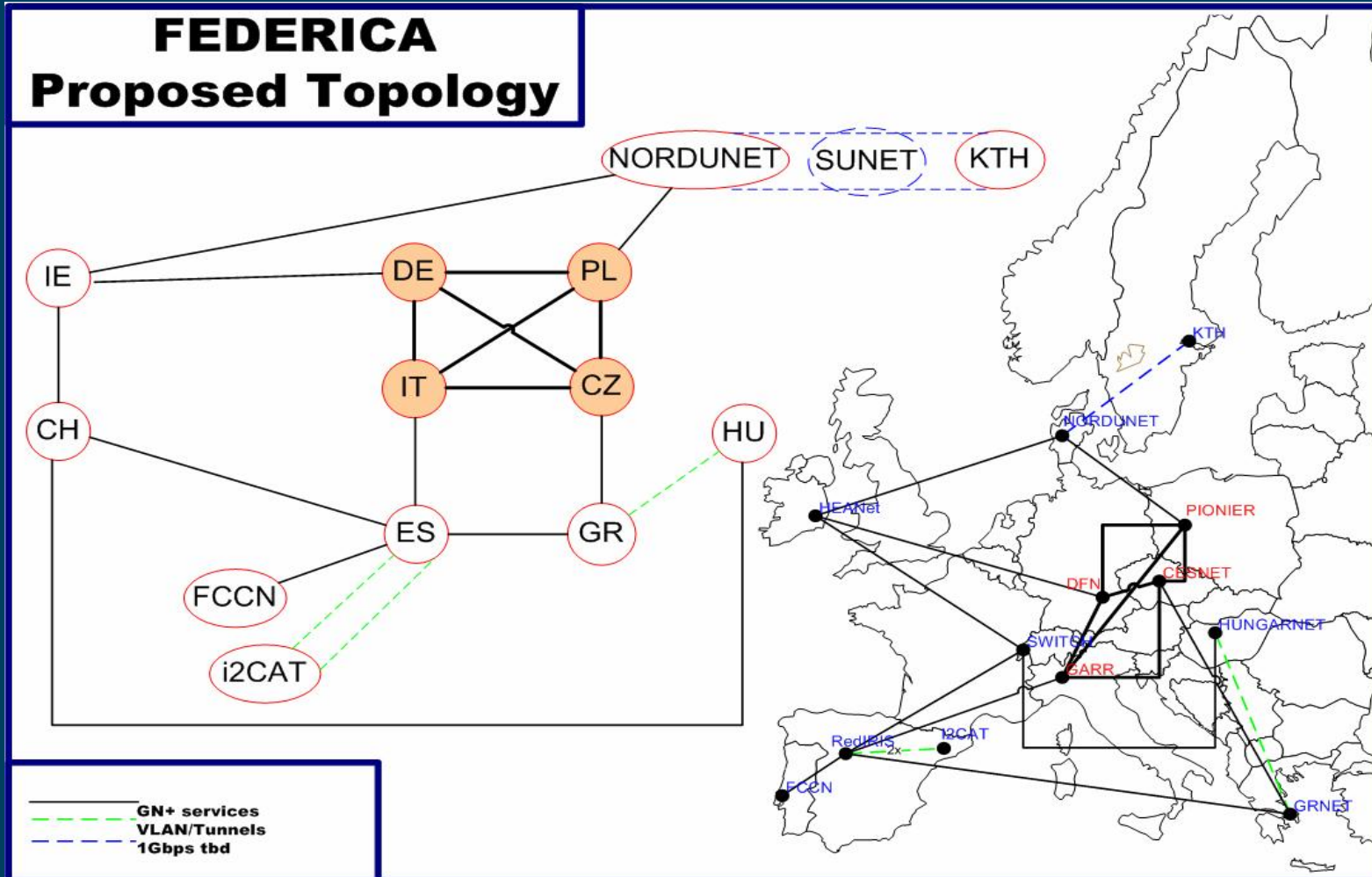

ICT e-Infrastructures: A CONCERTED EUROPEAN EFFORT



Research Networking & HPC/GRID communities common mission:

Provision of leading edge *e-Infrastructures* for Research & Advancement of HPCN technologies as **European added value**



NTUA – NATIONAL TECHNICAL
UNIVERSITY OF ATHENS

